

Operating Instructions

PLEASE READ BEFORE USE AND SAVE.

KX-TGA400B is the optional cordless handset for the KX-TG4000B. These operating instructions cover most of the features of this cordless handset.

Please read the KX-TG4000B operating instructions for further details.

Accessories (included)

For extra orders, call
1-800-332-5368.

- Chargerone
- AC Adaptor.....one
Order No. KX-TCA1-G
- Belt Clip.....one
Order No. PQKE10101Z1

Contents

Installation	1	Calling Back from the Caller List ..	7
Location of Controls.....	2	Voice Mail System	7
Registering Cordless Handsets...	3	Automated Attendant System.....	8
Making Calls.....	3	Listening to Messages.....	9
Answering Calls.....	4	Delivering Your Own Message	10
Intercom.....	4	Remote Operation from a Touch	
Transferring a Call	4	Tone Phone	10
Storing Names and Numbers		Wall Mounting.....	11
in the Directory	5	Using an Optional Headset.....	11
Dialing from the Directory	6	Canceling Handset Registration ..	11
Erasing an Item in the Directory ..	6	Using the Belt Clip	12
Caller ID Service.....	6	Battery Replacement.....	12
Viewing the Caller List.....	7		

Installation

Connecting the AC adaptor to the charger

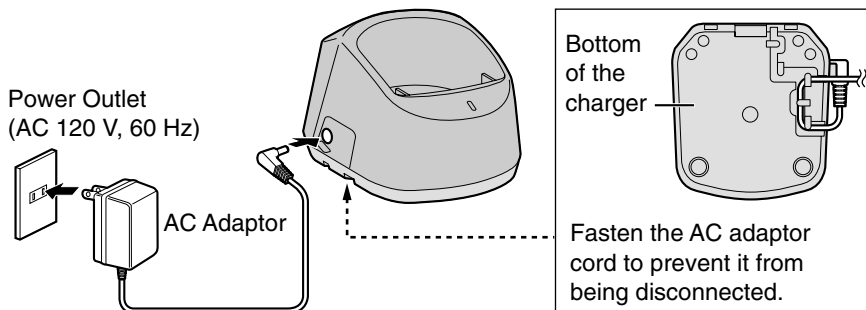

- USE ONLY WITH Panasonic AC ADAPTOR KX-TCA1 (Order No. KX-TCA1-G).
- The AC adaptor must remain connected at all times. (It is normal for the adaptor to feel warm during use.)

Charging the battery

Place the cordless handset on the charger and charge for **about 8 hours** before initial use. Make sure the handset faces forward as shown.

- The CHARGE indicator lights.
- If you charge the discharged battery, it will be charged quickly. In that case the handset may feel warm. This is normal.
- Recharge the battery when:
 - “Recharge” is displayed,
 - “” flashes on the display, or
 - the handset beeps intermittently while it is in use.

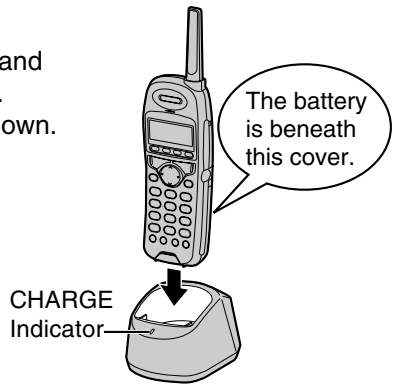

Handset battery information

After your Panasonic battery is fully charged:

Operation	Approx. battery life
While in use (TALK)	Up to about 8 hours
While not in use (Standby)	Up to about 4 days

- **Clean the charge contacts of the handset and the charger with a soft, dry cloth once a month. Clean more often if the unit is subject to grease, dust or high humidity.** Otherwise the battery may not charge properly.

Location of Controls

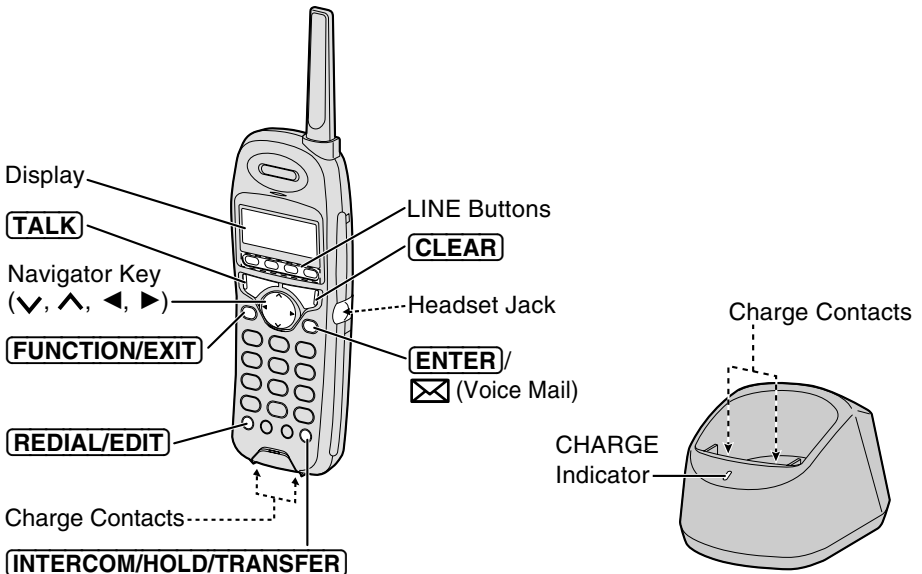

Registering Cordless Handsets

Registration is necessary for cordless handsets. A handset will be assigned the number at registration. The handset number is used as the extension number (p. 4, 8). You can register up to 8 cordless handsets at the KX-TG4000B base unit.

Make sure that the base unit and cordless handset are in the standby mode. Registration must be completed within 1 minute.

1 Base unit:

Press **FUNCTION**.

2 Select "Registration" by pressing **▼** or **▲**, and press **▶**.

3 Select "HS registration" by pressing **▼** or **▲**, and press **▶**.

4 Cordless handset:

Press **FUNCTION**.

5 Select "Registration" by pressing **▼** or **▲**, and press **▶**.

6 Press **▶** to select "HS registration".

7 Base unit/Cordless handset:

Wait until a beep sounds and until both of the displays show the assigned handset number.

Press **EXIT**.

- The handset number ([1]–[8]) is displayed in the standby mode.

If a PIN (Personal Identification Number) has been stored:

Follow steps 1 to 6, and enter the PIN. Press **ENTER**.

Making Calls

Four calls can be handled simultaneously on separate telephone lines by the base unit and 3 cordless handsets (or by 4 cordless handsets).

1 Press **TALK**.

- You can press a line button instead of pressing **TALK**.

2 Dial a phone number.

3 To hang up, press **TALK** or place the handset on the charger.

- To adjust the receiver volume, press **▲** or **▼** while talking.

To dial after confirming the entered number:

Enter a phone number, and press **TALK**.

- To redial a number from the redial list (contains the last 10 numbers dialed), press **REDIAL** until the desired number is displayed, and press **TALK**.

Answering Calls

Four calls can be handled simultaneously by the base unit and 3 cordless handsets (or by 4 cordless handsets).

Press **TALK**.

- You can press the called line button instead of pressing **TALK**.
- You can also answer a call by pressing any dialing button **0** to **9**, ***** or **#**.

OR

If the handset is on the charger, just lift up.

What “ **L1**, **L2**, **L3**, **L4** ” on the display mean:

Off (invisible): The line is free.

On: The line is being used.

Flashing:

A call is on hold. The Automated Attendant System or Answering System is responding to a call.

Flashing quickly:

A call is being received.

- During a conversation, if two tones sound, an incoming call is being received on another line. To answer the second call while holding the first call, press **HOLD** and press the called line button. To return to the first call, press the line button.

Intercom

Each number assigned to a handset at registration is the extension number (p. 3). The base unit extension number is 0.

Making intercom calls

- 1** Press **INTERCOM**.
 - 2** To page the base unit, enter **0**.
To page another handset, enter the extension number (**1** to **8**).
 - 3** To end the intercom, press **TALK** or place the handset on the charger.
- To answer an intercom call, press **TALK** or lift the handset off the charger.

Transferring a Call

- 1** During a call, press **TRANSFER**.
- 2** To page the base unit, enter **0**.
To page another handset, enter the extension number (**1** to **8**).
- 3** If required, wait for the paged party to answer, and you can announce the transfer.
If not required, go to step 4.
- 4** To complete the transfer, press **TALK** or place the handset on the charger.

Storing Names and Numbers in the Directory —

You can store names and phone numbers in the directory. The cordless handset can store up to 50 items. All directory items are sorted by the first word in alphabetical order. Using the directory, you can make a call by selecting a name on the display.

Make sure that the cordless handset is in the standby mode.

- 1** Press **[FUNCTION]**.
- 2** Press **▶** to select “Save directory”.
- 3** Enter a name, up to 16 characters, using the dialing buttons (see below).
 - To move the cursor, press **◀** or **▶**.
- 4** Press **[ENTER]**.
- 5** Enter a phone number, up to 22 digits.
- 6** Press **[ENTER]**.
 - To store other items, repeat from step 2.
- 7** Press **[EXIT]**.
 - To exit the programming mode any time, press **[EXIT]**.

Selecting characters to enter names

The dialing buttons can be used to enter letters and symbols. Pressing each button selects a character as shown below.



Keys	Index	Keys	Index
[1]	# & ' () * , - . / 1	[7]	P Q R S p q r s 7
[2]	A B C a b c 2	[8]	T U V t u v 8
[3]	D E F d e f 3	[9]	W X Y Z w x y z 9
[4]	G H I g h i 4	[0]	0 blank
[5]	J K L j k l 5	◀	To move the cursor to the left.
[6]	M N O m n o 6	▶	To move the cursor to the right.

- To enter another character using the same number key, press **▶** to move the cursor to the next space.

If you make a mistake while entering a name:

Press **◀** or **▶** to move the cursor to the incorrect character. Press **[CLEAR]** to delete the character. Enter the correct character. To erase all characters, press and hold **[CLEAR]**.

Dialing from the Directory

- 1 Press ◀ or ▶ to enter the directory.
- 2 Press ▼ or ▲ to find the desired item.

To search for a name by initial:

Press the dialing button for the first letter of the desired name until any name with the same initial is displayed. Press ▼ until the name is displayed.

- 3 Press **TALK**.
 - You can press a line button instead of pressing **TALK**.
- In steps 1 and 2, you can leave the directory by pressing **EXIT**.

Erasing an Item in the Directory

Make sure that the cordless handset is in the standby mode.

- 1 Press ◀ or ▶ to enter the directory.
- 2 Press ▼ or ▲ to find the directory item you want to erase.
 - To search for the item by initial, see above.
- 3 Press **CLEAR**.
- 4 Press **ENTER**, and press **EXIT**.

Caller ID Service

This unit is compatible with a Caller ID service offered by your telephone company. After subscribing to a Caller ID service, the calling party's information will be displayed after the first ring.

The unit can record information of up to 30 different callers in the Caller List. The Caller List information is sorted from the most recent to the oldest call. When the 31st call is received, the oldest call is deleted.

How caller information is displayed when a call is received

The display shows the caller's name, number and the called line after the first ring.

- After you answer the call, the display will show the length of the call.
- When more than one line is receiving a call at the same time, each caller's information will be displayed alternately.
- Caller information cannot be displayed in the following cases:
 - If the caller dialed from an area which does not provide a Caller ID service, the display will show "Out of area".
 - If the caller has requested not to display his/her information, the display will show "Private caller".

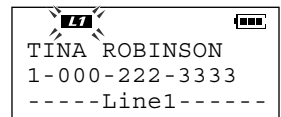

Viewing the Caller List

If you have received new calls, "Received calls" will be displayed in the standby mode. Caller List information includes the caller's name and phone number, and the time and date the call was received.

Make sure that the cordless handset is in the standby mode.

1 Press ∇ or \blacktriangle to enter the list.

- The number of new calls is displayed.

10 new calls $\nabla\blacktriangle$ \blacktriangleright =Directory

2 To search from the most recent call, press ∇ .

To search from the oldest call, press \blacktriangle .

- To scroll between callers, press ∇ or \blacktriangle .

JACK SMITH 1-234-567-8901 3:10P JUN. 9
--

3 To exit the list, press **EXIT**.

- If there is no name information for a caller, the display will only show the phone number.
- After viewing all of the new call entries, "Received calls" will disappear.

What " \surd " means:

You have viewed a new call, answered the call or called back the caller.

NANCY BROWN 1-000-222-3333 3:10P JUN.10 \surd

If a caller calls more than once:

The number of times the same caller called is displayed ($\times 2$ to $\times 9$). After checking, $\times 2$ to $\times 9$ will be replaced with " \surd ".

Ex. The caller called 5 times.

NANCY BROWN 1-000-222-3333 3:10P JUN.10 $\times 5$
--

Calling Back from the Caller List

1 Press ∇ or \blacktriangle to enter the list.

2 Press ∇ or \blacktriangle to find the desired caller.

3 Press **TALK**.

- You can press a line button instead of pressing **TALK**.

- In step 2, if required, edit the phone number by pressing **EDIT**. The phone number will be edited into one of 4 patterns as follows:

Ex.

1-234-321-5555	\rightarrow	321-5555	\rightarrow
\rightarrow	234-321-5555	\rightarrow	1-321-5555

Voice Mail System

The Voice Mail System allows you to receive and deliver voice messages using mailboxes. The unit accommodates one general delivery mailbox and a maximum of 8 personal mailboxes which are assigned to the registered cordless handsets. The mailbox numbers are the same as the handset numbers.

The Voice Mail System works fully with the Automated Attendant System, which routes incoming calls to a specified mailbox and allows a caller to leave a message. With the Answering System, all calls are routed to the general delivery mailbox.

(continued \rightarrow)

You can use the Voice Mail System by accessing your mailbox. Each cordless handset user can only access his/her own mailbox. The general delivery mailbox is managed by the base unit user (operator). The cordless handset users can access this mailbox.

You can also access the Voice Mail System features remotely from a touch tone phone.

Setting the mailbox password

Assign a password to your mailbox to prevent unauthorized persons from accessing your mailbox and listening to the messages remotely from a touch tone phone. The preset password for each mailbox is a 4-digit number using the mailbox number. (Ex. "1111" for Mailbox 1, "2222" for Mailbox 2) You can stop unauthorized accesses to your personal mailbox from the cordless handset using this password. If required, turn the direct handset access mode OFF on your handset. Once you turn it OFF, no one can use the  (Voice Mail) button features and access the mailbox without entering the password. Your cordless handset comes from the factory set to ON. Make sure that the cordless handset is in the standby mode.

1. Press **FUNCTION**, and select "Voice mail" by pressing ∇ or \blacktriangle , and press \blacktriangleright .
2. Select "Set password" by pressing \blacktriangleright .
3. Enter a password using a 4-digit number (0000-9999), and press **ENTER**.
4. To turn the direct handset access mode ON, select "on" by pressing ∇ or \blacktriangle . To turn the mode OFF, select "off" by pressing ∇ or \blacktriangle .
5. Press **ENTER**, and press **EXIT**.

Automated Attendant System

The automated attendant answers incoming calls and then routes the callers to the base unit or the desired cordless handset.





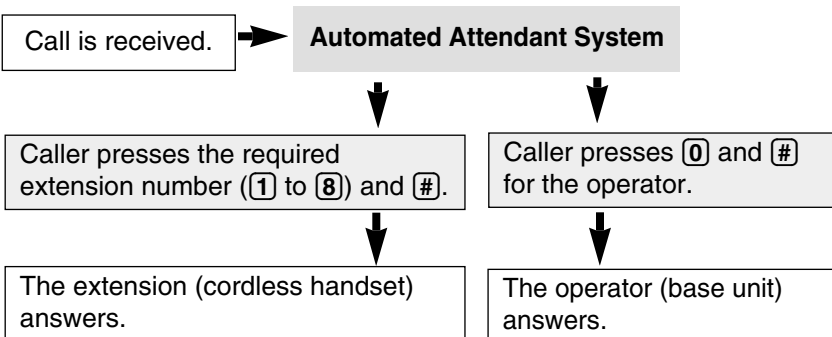

The base unit plays the role of operator with the cordless handsets as the extensions. Callers can reach desired mailboxes using this system to leave messages.

Calling the automated attendant









Setting the handset answer mode

If you turn ON the answer mode of your handset, calls will be greeted with a greeting message (see on the right) and callers can leave messages in your mailbox. To take calls, leave this mode OFF (factory preset).



- 1 While the handset is in the standby mode, press .
 - If the direct handset access mode is OFF (p. 8), enter the mailbox password and press .
 - If you have new messages, listen to all of them.
- 2 Press .
- 3 To select ON, press .
To select OFF, press .
- 4 Press .

Recording a personal greeting message





If the handset answer mode is ON, callers will hear a pre-recorded personal greeting message. You can also record your own greeting message of up to 2 minutes.

- 1 While the handset is in the standby mode, press .
 - If the direct handset access mode is OFF (p. 8), enter the mailbox password and press .
 - If you have new messages, listen to all of them.
- 2 Press .
- 3 Press .
- 4 After the tone, talk clearly. To end, press .
- 5 Press , and press .



Listening to Messages

If “” flashes and “Voice mail” is shown on your handset display, new messages have been received in your mailbox. During playback “” is displayed.





Listening to new messages

- 1 While the handset is in the standby mode, press .
 - If the direct handset access mode is OFF (p. 8), enter the mailbox password and press .
 - New messages are played.
- 2 After listening to all new messages;
To listen to all messages, press .
- To listen to messages in the general delivery mailbox,** press .
- To end the operation,** press .

During playback:

- To adjust the handset volume, press  or .

To transfer a message to other mailboxes:

While the message you want to transfer is being played or before the start of the next message, press . Enter the destination mailbox numbers using the corresponding dialing buttons (,  to ), and press .

To erase a message:

While the message you want to erase is being played or before the start of the next message, press  or **CLEAR**.

Delivering Your Own Message

You can send an identical message of up to 3 minutes, to several mailboxes.

- 1** While the handset is in the standby mode, press **☒**.
 - If the direct handset access mode is OFF (p. 8), enter the mailbox password and press **☒**.
 - If you have new messages, listen to all of them.
- 2** Press **2**.
- 3** Enter the destination mailbox numbers using the corresponding dialing buttons (**0**, **1** to **8**).
- 4** Press **#**.
- 5** After the tone, talk clearly. To end recording, press **1**.
- 6** Press **2**, and press **☒**.

Remote Operation from a Touch Tone Phone

You can access the Voice Mail System from any touch tone phone if the Automated Attendant System or the Answering System is on for any of lines. You can listen to recorded messages in your mailbox and the general delivery mailbox. When you access your mailbox, you are required to enter the mailbox password (p. 8).

How to access the Voice Mail System

Call the line's phone number to which the Automated Attendant System or the Answering System is assigned.

Press ***** and enter your mailbox password during or after the greeting message.

After the number of new messages is announced, new messages will be played.

To end the remote operation, press ***** and hang up.

- After each message playback, you can select options by following the voice menu (guidance). After all new messages have been played, you will hear a different menu.
- Press buttons firmly.

Wall Mounting

The charger can be wall mounted.

Install screws using the wall template on the right. Connect the AC adaptor. Mount the charger, then slide it down.

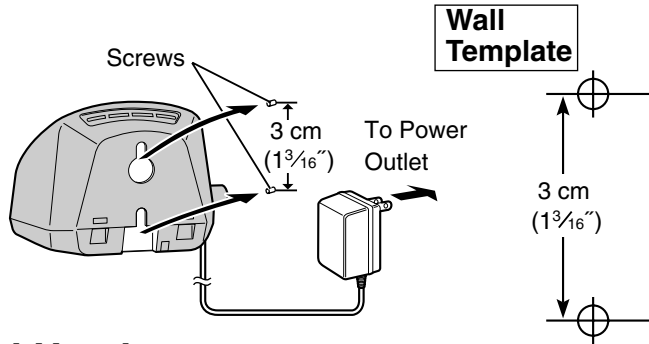

Using an Optional Headset

Plugging an optional headset into the cordless handset allows a hands-free phone conversation. Please use only the Panasonic KX-TCA88 headset. To order, call the accessories telephone number on page 1.

Connecting the headset to the cordless handset

Open the headset jack cover, and connect the headset to the headset jack as shown.

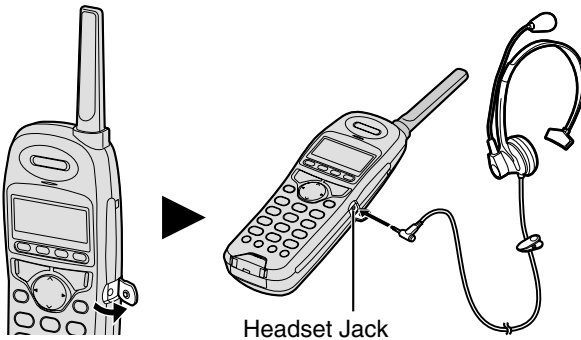

When the headset is connected, make sure to use the headset to talk with the caller. If you want to have a normal cordless phone conversation, disconnect the headset.

Canceling Handset Registration

Make sure that the base unit and cordless handset are in the standby mode.

Base unit:

1. Press **FUNCTION**.
2. Select "Registration" by pressing **▼** or **▲**, and press **▶**.
3. Select "Deregistration" by pressing **▼** or **▲**, and press **▶**.
4. Press **▶** or **◀** to move the cursor to the handset number to be canceled.
5. Press **ENTER**.
6. Press **CLEAR**, and press **EXIT**.

Cordless handset:

1. Press **FUNCTION**.
2. Select "Registration" by pressing **▼** or **▲**, and press **▶**.
3. Select "Deregistration" by pressing **▼** or **▲**, and press **▶**.
4. Press **CLEAR**, and press **EXIT**.
 - [-] is displayed.

Using the Belt Clip

You can hang the cordless handset on your belt or pocket using the belt clip.

To attach the belt clip

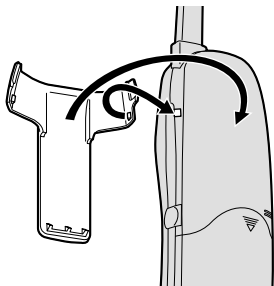

To remove the belt clip



Battery Replacement

If “Recharge” is displayed and/or “” flashes on the display after being fully charged, replace the battery with a new Panasonic HHR-P506 (PQHHR150AA21) battery. To order, call the accessories telephone number on page 1.

- 1** Remove the cover by sliding while pressing the arrow.
- 2** Replace the battery, and close the cover. Be sure to charge the new battery for about 8 hours.

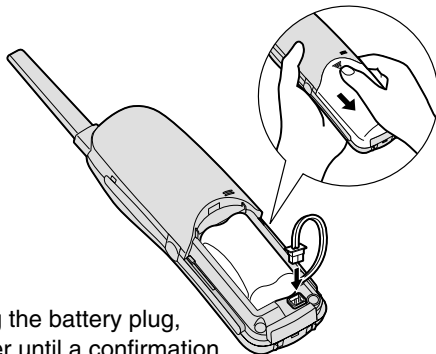

- After replacing the battery or re-connecting the battery plug, be sure to place the handset on the charger until a confirmation tone sounds or the battery strength prompt displays.
- The handset battery is a Nickel-Metal Hydride battery. You cannot recycle this battery.

CAUTION:

To reduce the risk of fire or injury to persons, read and follow these instructions.

1. Use only the battery(ies) specified.
2. Do not dispose of the battery(ies) in a fire. They may explode. Check with local waste management codes for special disposal instructions.
3. Do not open or mutilate the battery(ies). Released electrolyte is corrosive and may cause burns or injury to the eyes or skin. The electrolyte may be toxic if swallowed.
4. Exercise care in handling batteries in order not to short the battery to conductive materials such as rings, bracelets, and keys. The battery and/or conductor may overheat and cause burns.
5. Charge the battery(ies) provided with or identified for use with this product only in accordance with the instructions and limitations specified in this manual.

WARNING:

TO PREVENT FIRE OF SHOCK HAZARD, DO NOT EXPOSE THIS PRODUCT TO RAIN OR ANY TYPE OF MOISTURE.

FCC and Other Information

When programming emergency numbers and/or making test calls to emergency numbers:

1. Remain on the line and briefly explain to the dispatcher the reason for the call before hanging up.
2. Perform such activities in the off-peak hours, such as early morning hours or late evenings.

This device complies with Part 15 of the FCC Rules. Operation is subject to the following two conditions: (1) This device may not cause harmful interference, and (2) this device must accept any interference received, including interference that may cause undesired operation.

Privacy of communications may not be ensured when using this phone.

CAUTION:

Any changes or modifications not expressly approved by the party responsible for compliance could void the user's authority to operate this device.

Note:

This equipment has been tested and found to comply with the limits for a Class B digital device, pursuant to Part 15 of the FCC Rules. These limits are designed to provide reasonable protection against harmful interference in a residential installation. This equipment generates, uses, and can radiate radio frequency energy and, if not installed and used in accordance with the instructions, may cause harmful interference to radio communications. However, there is no guarantee that interference will not occur in a particular installation. If this equipment does cause harmful interference to radio or television reception, which can be determined by turning the equipment off and on, the user is encouraged to try to correct the interference by one or more of the following measures:

- Reorient or relocate the receiving antenna.
- Increase the separation between the equipment and receiver.
- Connect the equipment into an outlet on a circuit different from that to which the receiver is connected.
- Consult the dealer or an experienced radio/TV technician for help.

**Panasonic Consumer Electronics Company,
Division of Matsushita Electric Corporation of America**
One Panasonic Way, Secaucus, New Jersey 07094

**Panasonic Sales Company,
Division of Matsushita Electric of Puerto Rico, Inc.**
Ave. 65 de Infantería, Km. 9.5, San Gabriel Industrial Park
Carolina, Puerto Rico 00985

Panasonic World Wide Web address: <http://www.panasonic.com>

Panasonic's e-mail address for customer inquiries:
consumerproducts@panasonic.com